

LTE Industrial Router

ICR-2031

USER MANUAL



ADVANTECH

© 2023 Advantech Czech s.r.o. No part of this publication may be reproduced or transmitted in any form or by any means, electronic or mechanical, including photography, recording, or any information storage and retrieval system without written consent. Information in this manual is subject to change without notice, and does not represent a commitment on the part of Advantech.

Advantech Czech s.r.o. shall not be liable for incidental or consequential damages resulting from the furnishing, performance, or use of this manual.

All brand names used in this manual are the registered trademarks of their respective owners. The use of trademarks or other designations in this publication is for reference purposes only and does not constitute an endorsement by the trademark holder.

Used symbols



Danger – Information regarding user safety or potential damage to the router.



Attention – Problems that can arise in specific situations.



Information, notice – Useful tips or information of special interest.



Advantech Czech s.r.o., Sokolska 71, 562 04 Usti nad Orlici, Czech Republic
Document No. MAN-0057-EN, revision from June 20, 2023. Released in the Czech Republic.

Contents

1	Product Overview	2
1.1	Product Introduction	2
1.2	Product Usage Examples	3
1.3	Hardware Overview	5
1.4	Order Codes	7
1.5	Product Revisions	7
1.6	Package Contents	8
1.7	Product Dimensions	9
1.8	Mounting Recommendations	11
1.9	Wall Mounting	12
1.10	DIN Rail Mounting	13
1.11	Product Label	14
2	Hardware Functionality	15
2.1	SIM Card Slot	15
2.2	Antennas	16
2.3	Ethernet Interfaces	16
2.4	Power Supply	17
2.5	I/O Port Interfaces	18
2.6	LED Status Indication	19
2.7	Reset Functions	20
3	First Use	21
3.1	Accessories Connection	21
3.2	Router Configuration	21
4	Technical Specifications	23
4.1	Basic Parameters	23
4.2	Standards and Regulations	24
4.3	Type Tests and Environmental Conditions	25
4.4	Parameters of Cellular Module	26
4.5	Parameters of WiFi	27
4.6	Parameters of I/O Ports	28
4.7	System Configuration	28
	Appendix A: Troubleshooting	29
	Appendix B: Customer Support	32

Appendix C: Regulatory & Safety Information	33
Appendix D: Related Documents	35

List of Figures

1	Access to the Internet from LAN	3
2	Backed up Access to the Internet	3
3	Using VPN Tunnel	4
4	Hardware Overview of the Router	5
5	Router Dimensions – Top, Side and Front View with Wall Mount Clip	9
6	Router Dimensions – Top, Side and Front View with DIN Rail Clip	10
7	Screwed Wall Mounting Clip	12
8	Position of the DIN Rail Clip	13
9	Removing Router from the DIN Rail	13
10	Product Label	14
11	SIM Card Insertion	15
12	Ethernet Connector Pinout	16
13	Connection of Power Supply	17
14	Position of the Grounding Screw	17
15	I/O Connector Pinout	18
16	Functional Scheme of the Binary Interface	18
17	Resetting the Router	20
18	Router’s Web Interface	22

List of Tables

1	Hardware Overview of the Router	6
2	Order Codes Overview	7
3	HW Revisions History	7
4	Contents of Package	8
5	Ethernet Connector Pinout Description	16
6	Power Supply Pinout	17
7	I/O Ports Pinout	18
8	LED Status Indication	19
9	Basic Parameters	23
10	Standards and Regulations	24
11	Type Tests and Environmental Conditions	25
12	Technical Parameters of Cellular Module	26
13	Technical Parameters of WiFi	27
14	Electrical Characteristics of Binary Input	28
15	System Configuration	28

1. Product Overview

1.1 Product Introduction

Industrial cellular router ICR-2031 is designed for wireless communication in mobile networks that use traditional cellular technologies.

The primary purpose of this router is its use in the Category 4 (**Cat.4**) services on the cellular **LTE** network. Cat.4 rated router is capable of achieving typical speeds in 4G coverage areas where the network is enabled with 20 MHz of contiguous spectrum. The peak **downlink** data rate for Category 4 is approximately **150 Mbps**. In the **uplink**, LTE Category 4 provides a peak data rate of **50 Mbps**.

The router is equipped with one **Ethernet port** and with one **digital input** together with one **digital output**. The router can be equipped with a **WiFi module**, but this must be part of the initial configuration – it cannot be assembled to the router at some point in the future.

The router supports **VPN tunnel** creation using various protocols to ensure safe communications. The router provides diagnostic functions which include automatic monitoring of the wireless and wired connections, automatic restart in case of connection losses, and a hardware watchdog that monitors the router status.

With open Linux platform and wide possibilities of programming customer SW applications in **Python, C/C++**. The Advantech existing app library **Router Apps** (formerly *User modules*) with apps already developed to enhance specific router functionality including industrial protocol conversions and support of IoT platforms such as **MS Azure, Cumulocity, ThingWorx**, and others are supported on the router.

Examples of possible applications

- mobile office
- fleet management
- security system
- telematic
- telemetric
- remote monitoring
- vending and dispatcher machines

1.2 Product Usage Examples

The router is primarily intended for these basic situations:

I. Access to the Internet from LAN

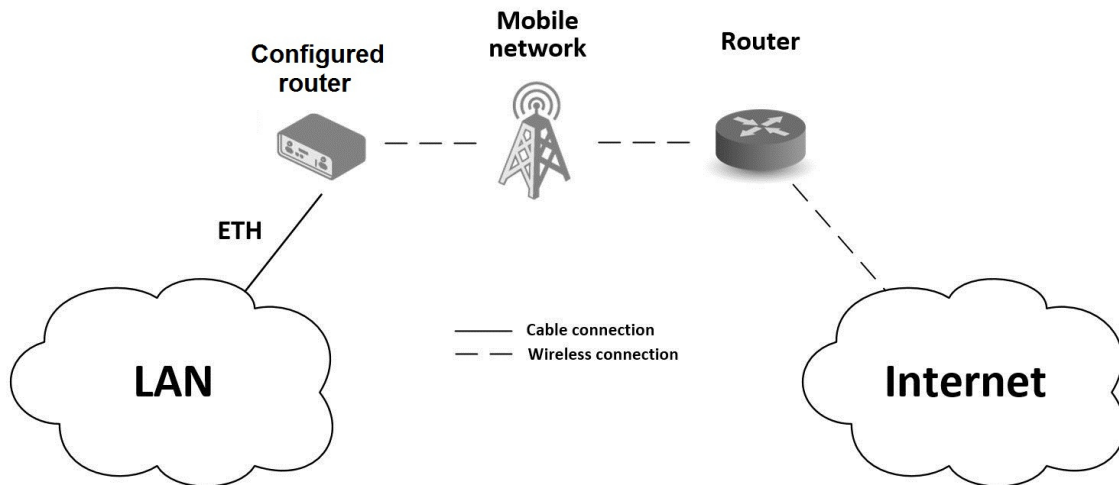

Figure 1: Access to the Internet from LAN

II. Backed up access to the Internet (from LAN)

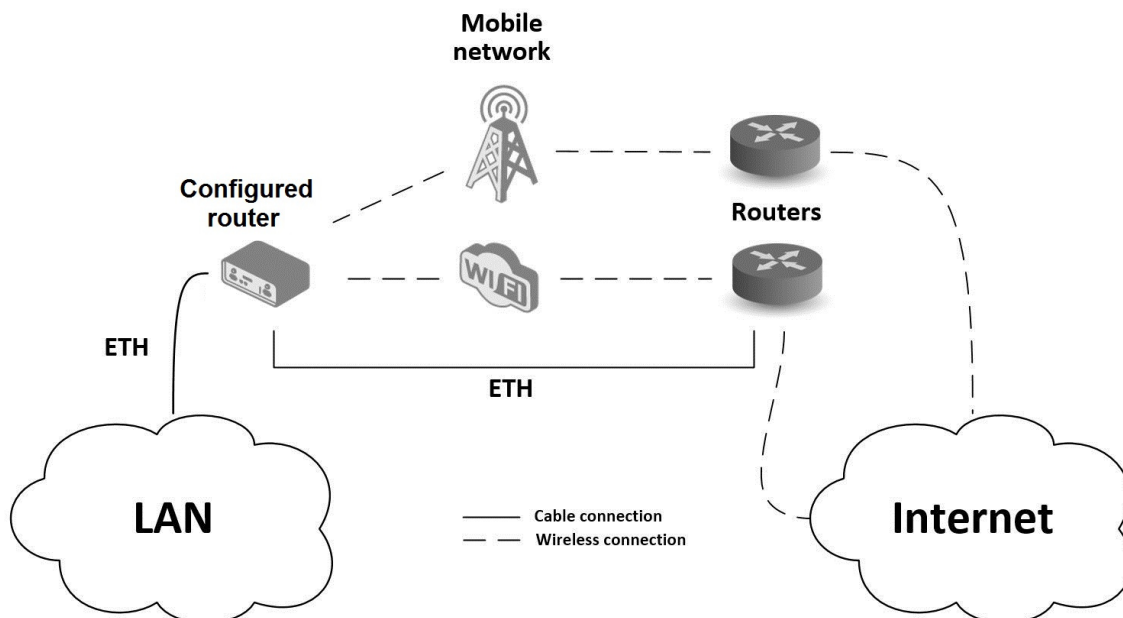

Figure 2: Backed up Access to the Internet

III. Secure networks interconnection or using VPN

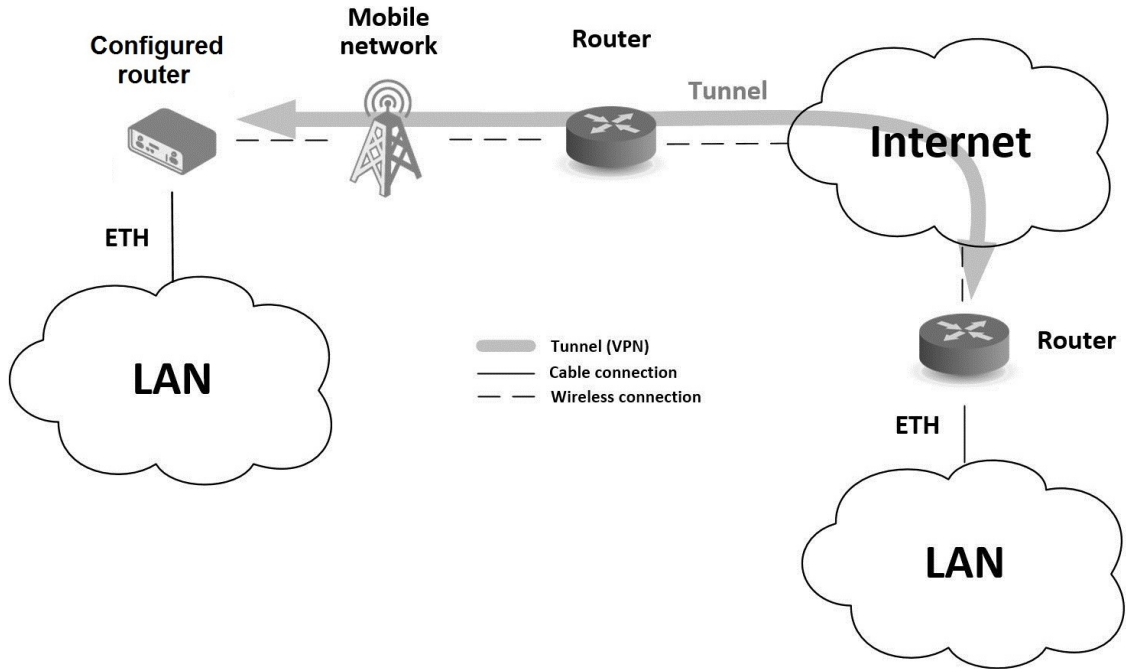

Figure 3: Using VPN Tunnel

1.3 Hardware Overview

The router case preview is shown in Figure 4. A short description of hardware parts of the router is listed in Table 1, including the links to the chapters with a detailed description.

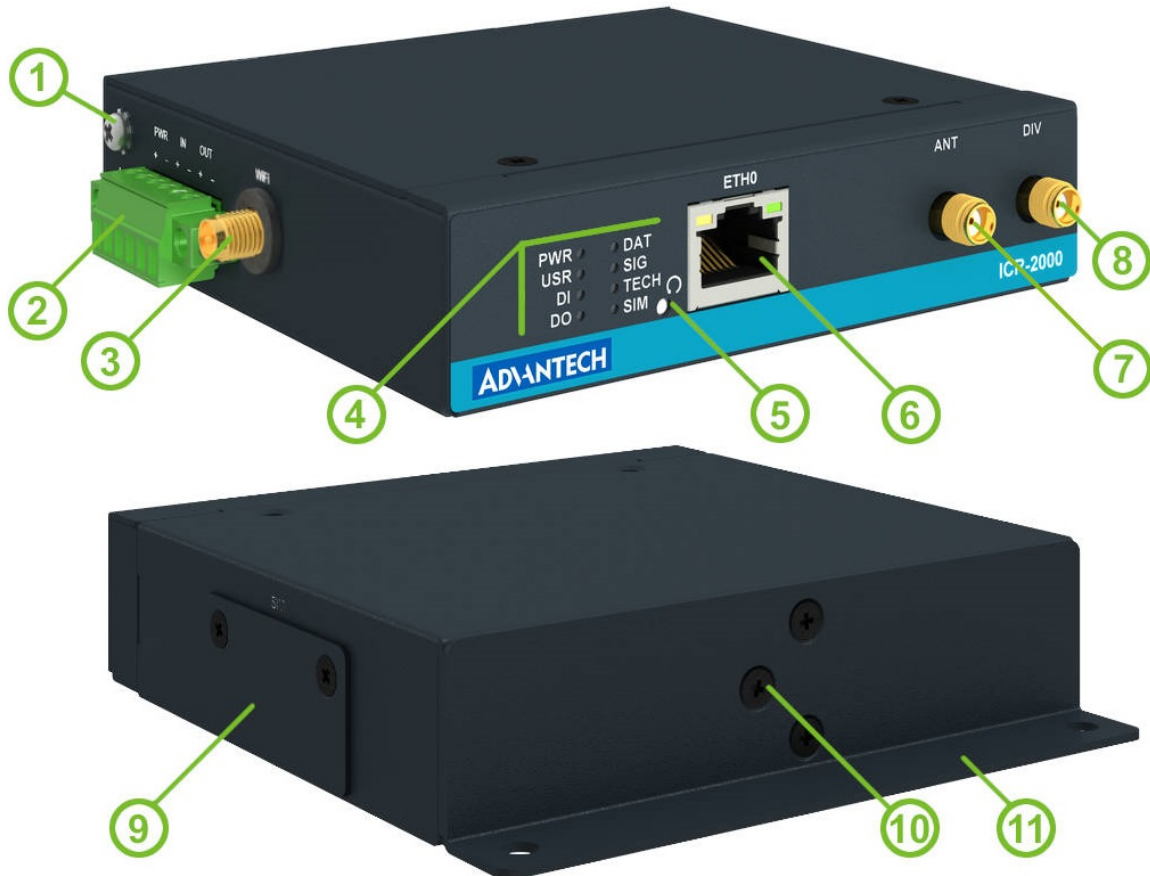

Figure 4: Hardware Overview of the Router

#	Item/Caption	Type	Description
1	Grounding screw	M3	Pay attention to proper grounding; see Chapter 2.4.
2	PWR IN/OUT	6-pin terminal	Power supply, binary input, and binary output interfaces. See Chapter 2.4, Chapter 2.5 for more information, Chapter 4.6 for I/O parameters.
3	WiFi	RP-SMA female	Connector for the WiFi antenna; see Chapter 2.2 and Chapter 4.5 for WiFi parameters.
4	LEDs	-	Status LED indication; see Chapter 2.6.
5	RST	-	Button to reboot the router or to restore the default configuration; see Chapter 2.7.

Continued on the next page

Continued from previous page

#	Item/Caption	Type	Description
6	ETH0	RJ45	100 MB Ethernet connection for the LAN; see Chapter 2.3.
7	ANT	SMA female	Connector for the main antenna of the cellular module; see Chapter 2.2.
8	DIV	SMA female	Connector for the second antenna of the cellular module (required for the MIMO DL); see Chapter 2.2.
9	SIM slot	Micro SIM	One SIM card slot; see Chapter 2.1.
10	DIN clip	-	DIN rail clip, not included as standard accessories; see Chapter 1.10.
11	Wall clip	-	Wall mounting clip, included as standard accessories; see Chapter 1.9.

Table 1: Hardware Overview of the Router

1.4 Order Codes

Order codes overview is shown in the table below.

Order code	Features – interfaces
ICR-2031	LTE Cat.4 with 3G/2G fallback cellular module, 64 MB NOR Flash, 1x ETH, 1x Binary Input, 1x Binary Output, 1x SIM reader
ICR-2031W	LTE Cat.4 with 3G/2G fallback cellular module, 64 MB NOR Flash, 1x ETH, 1x Binary Input, 1x Binary Output, 1x SIM reader, WiFi

Table 2: Order Codes Overview

1.5 Product Revisions

For the product revision history, see the table below. The revision number is printed on the packaging and product labels.

The router GUI can also display the product revision under *Status -> General -> System Information -> Product Revision*. Please note that the default revision (Rev.1.0) is unavailable here.

Rev.#	Description
1.0	Initial version (revision not printed on the labels).
2.0	New design of the mainboard; see PCN-2023-05 for details.

Table 3: HW Revisions History

1.6 Package Contents

The standard set of router includes items listed in the following table:





Item#	Description	Figure	Q'ty
1	Router		1 pcs
2	Wall mounting clip with screws		1 set
3	6-pin terminal block for power supply, digital input and digital output (deployed on the router)		1 pcs
4	Printed <i>Quick Start Guide Leaflet</i>		1 pcs

Table 4: Contents of Package

1.7 Product Dimensions

For the dimensions of the product see the figures below. Note that all sizes are measured in millimeters.

Variant with Wall Mounting Clip

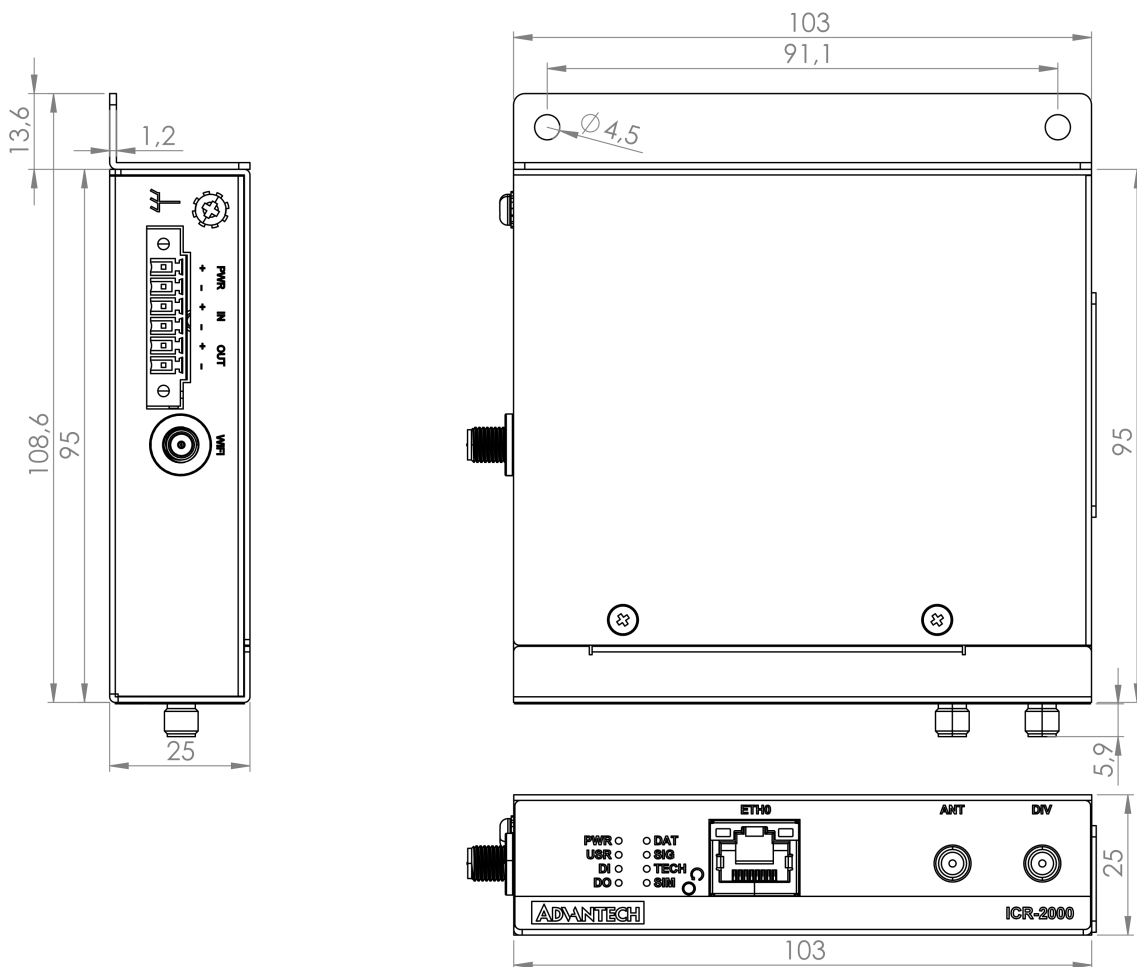

Figure 5: Router Dimensions – Top, Side and Front View with Wall Mount Clip

Variant with DIN Rail Clip

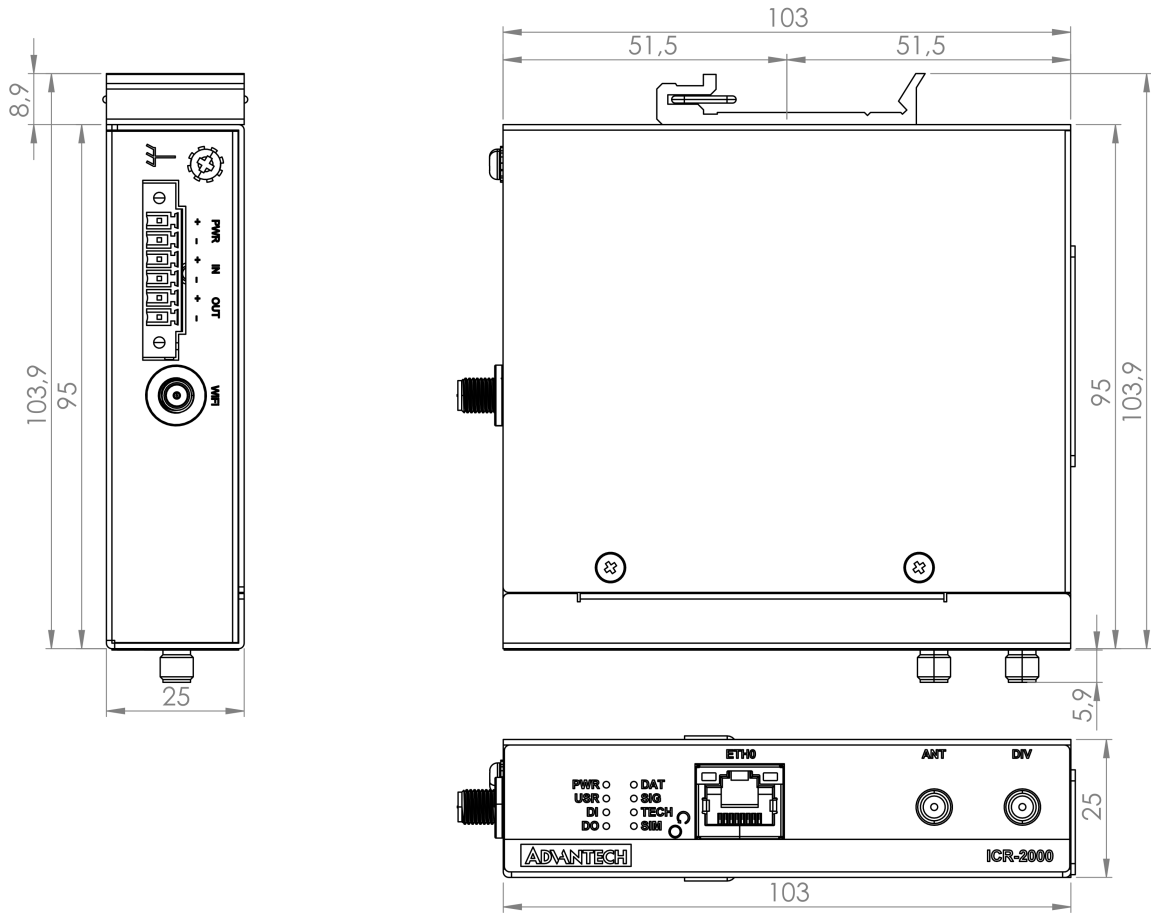

Figure 6: Router Dimensions – Top, Side and Front View with DIN Rail Clip

1.8 Mounting Recommendations

The router can be placed:

- on a flat surface,
- on a wall using the wall mounting clip (see Chapter 1.9),
- on a DIN rail EN 60715 with the metal DIN rail clip (see Chapter 1.10)

For most applications with a built-in router within a switchboard, it is possible to recognize two kinds of environments:

- A non-public, industry environment of low voltage with high interference,
- a public environment of low voltage and without high interference.

For both of these environments, it is possible to mount the router to a switchboard, after which there is no need to have examination immunity or issues in connection with EMC according to EN 61439-1:2011.



In compliance with the EN 61439-1:2011 specification, it is necessary to observe the following assembly instructions for a router attached to a switchboard:

- For whip antennas it is recommended to observe a minimum distance of 6 cm from cables and metal surfaces on every side in order to avoid interference. When using an external antenna separate from the switchboard it is necessary to fit a lightning conductor.
- When mounting a router on sheet-steel we recommend using a cable antenna.
- For all cables, we recommend to bind the bunch, and for this we recommend:
 - The length of the bunch (the combination of power supply and data cables) should be a maximum 1.5 m. If the length of data cables exceeds 1.5 m or if the cable is leading towards the switchboard, we recommend installing surge protectors.
 - Data cables must not have a reticular tension of ~ 230 V/50 Hz or ~ 120 V/60 Hz.
- Sufficient space must be left between each connector for the handling of cables,
- To ensure the correct functioning of the router we recommend the use of an earth-bonding distribution frame for the grounding of the grounding screw, see Chapter 2.4.

1.9 Wall Mounting



The wall mounting clip is supplied with the router as standard accessories.

The router can be screwed to a wall (or another surface) using the wall mounting clip. There are two holes on the clip with a diameter of 4 millimeters. For detailed information about the mounting dimensions see Figure 5 in Chapter 1.7.



When mounting the wall mounting clip, tighten the screws with max. torque of 0.4 Nm.

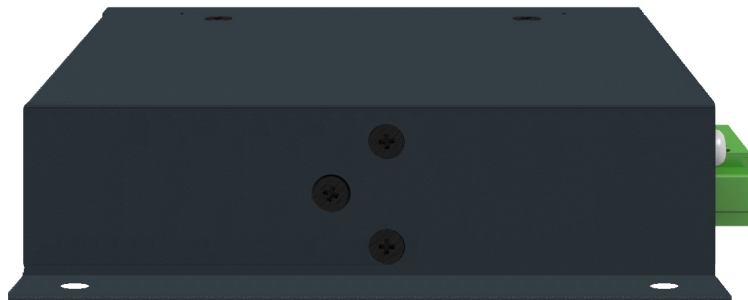

Figure 7: Screwed Wall Mounting Clip

1.10 DIN Rail Mounting

i The DIN rail clip is not supplied with the router as standard accessories, but it can be ordered by the order code *BB-DIN-ICR32*.

The DIN rail clip is suitable for a DIN rail according to EN 60715 standard only. The default position of the clip is shown in Figure 8.

! When mounting the DIN rail clip, tighten the screws with max. torque of 0.4 Nm.



Figure 8: Position of the DIN Rail Clip

To remove the router from the DIN rail it is necessary to lightly push down the router so that the bottom part of the DIN rail clip hitched to the DIN rail get out of this rail and then fold out the bottom part of the router away from the DIN rail, see Figure 9.

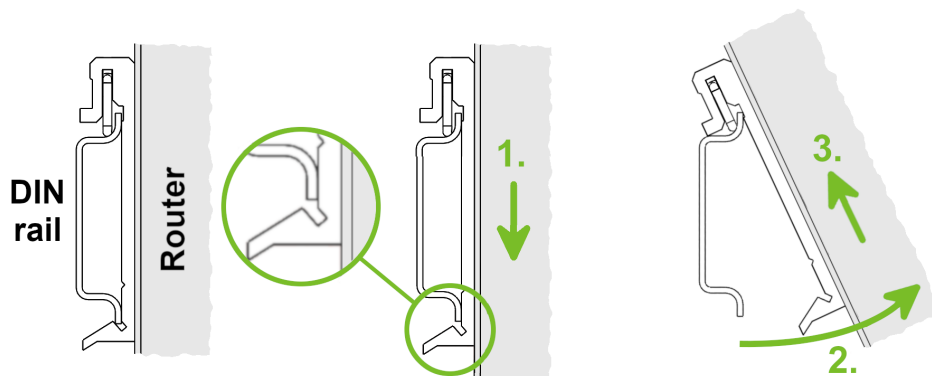

Figure 9: Removing Router from the DIN Rail

1.11 Product Label

The figure below shows an example of the product labels with all the information printed on them.



Figure 10: Product Label

2. Hardware Functionality

See Chapter 1.3 for the product hardware overview. Table 1 lists a short description of the hardware, including the links to the chapters with a detailed description.

2.1 SIM Card Slot

Slot for one SIM card is located on the router under a metal cover. If you intend to use this device to communicate over a cellular network, please place an activated data-provisioned SIM card into the SIM card reader.

You can install two SIM cards simultaneously to utilize the switching feature. The SIM cards may have different APNs (Access Point Names) adjusted. The SIM card changing procedure is described below. Enter the PIN in the router's web interface if the PIN is required for the SIM (*Administration -> Unlock SIM Card*).



Type of SIM card: Micro SIM (3FF) 15.0 x 12.0 x 0.76 mm.

Inserting the SIM card:

- Always disconnect the router from the power supply before handling the SIM card.
- Unscrew two screws on the SIM card cover and remove the cover.
- To remove an inserted SIM card, use the flat end of a spudger, or your fingernail, press the SIM card slightly into its slot until you hear a click. After hearing this click, release the card, and it will pop out of its slot.
- To insert a SIM card push card into the slot until it clicks into place.
- Place back the cover and fix it by two screws.

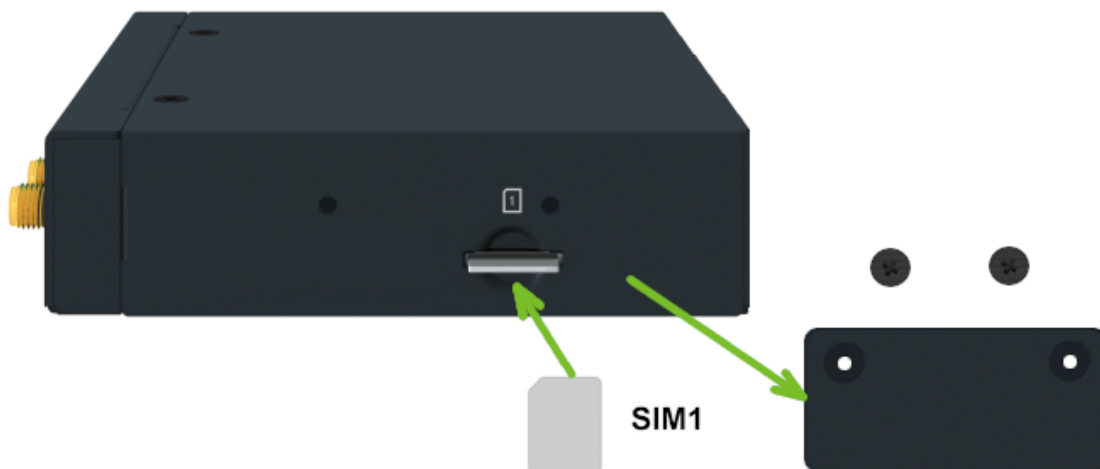

Figure 11: SIM Card Insertion

2.2 Antennas

Connect cellular antennas to the router to main (ANT) and secondary (DIV) SMA female connectors on the front panel. Connect WiFi antenna to the WiFi RP-SMA female connector on the side of the router.



Only run the router with a cellular antenna connected to the main antenna connector, as the energy from the transmission is effectively reflected by the open end and can damage the equipment.



The DIV cellular antenna is required for the MIMO DL functionality.



Recommended tightening moment for screwing the antenna to the SMA female connectors is 0.9 Nm.

2.3 Ethernet Interfaces



The maximum length of the cables connected to the Ethernet ports is 30 meters to meet the EMC immunity conditions.

The panel socket of RJ45 is used for Ethernet interface. The pinout of the socket is shown in Figure 12 and described in Table 5.

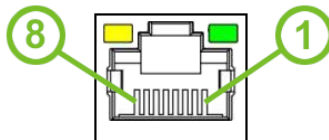

Figure 12: Ethernet Connector Pinout

Pin	Signal mark	Description
1	Tx+	Transmit Data+ (positive pole)
2	Tx-	Transmit Data- (negative pole)
3	Rx+	Receive Data+ (positive pole)
4	—	—
5	—	—
6	Rx-	Receive Data- (negative pole)
7	—	—
8	—	—

Table 5: Ethernet Connector Pinout Description



The isolation barrier of the Ethernet ports against the ground is 1500 V.

2.4 Power Supply

The pins of power supply are physically connected to the 6-pin terminal block panel socket located on the left panel. The connection of power supply is shown in Figure 13 and described in Table 6.

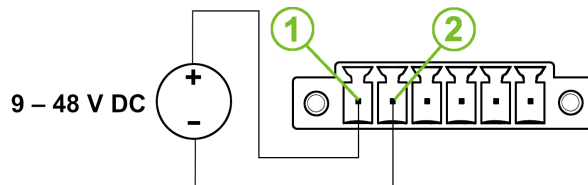

Figure 13: Connection of Power Supply

Pin	Signal mark	Description
1	PWR(+)	Positive pole of DC supply voltage (+9 to +48 V DC)
2	PWR(-)	Negative pole of DC supply voltage

Table 6: Power Supply Pinout

Required power supply voltage for the router is between +9 V and +48 V DC, see the connection scheme on Figure 13. Protection against reversed polarity without signaling is built into the router. For correct operation it is necessary that the power source is able to supply a peak current of 1 A.



Unit has to be supplied by a power supply specified as a Limited Power Source (LPS) or CEC/NEC Class 2 source of supply.

The metal case of the router is not connected to the negative pole of the power supply (common pole). If recommended for the installation environment, protect the router by grounding it properly by the grounding screw, see Figure 14.



Figure 14: Position of the Grounding Screw

2.5 I/O Port Interfaces



The maximum length of wires connected to the I/O ports is 3 meters to meet the EMC immunity conditions.

The pins of I/O interface are physically connected to the 6-pin terminal block panel socket located on the left panel. The pinout of one binary input and one binary output is shown in Figure 15 and described in Table 7.

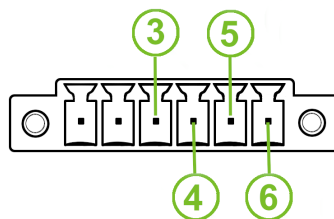

Figure 15: I/O Connector Pinout

Pin	Signal mark	Description
3	IN(+)	The binary input (positive pole)
4	IN(-)	The binary input (negative pole)
5	OUT(+)	The binary output (positive pole)
6	OUT(-)	The binary output (negative pole)

Table 7: I/O Ports Pinout

The I/O user interface is designed for binary input processing and binary output control. For detailed electrical parameters see Chapter 4.6. The functional scheme of connection for the binary input and binary output is in Figure 16.

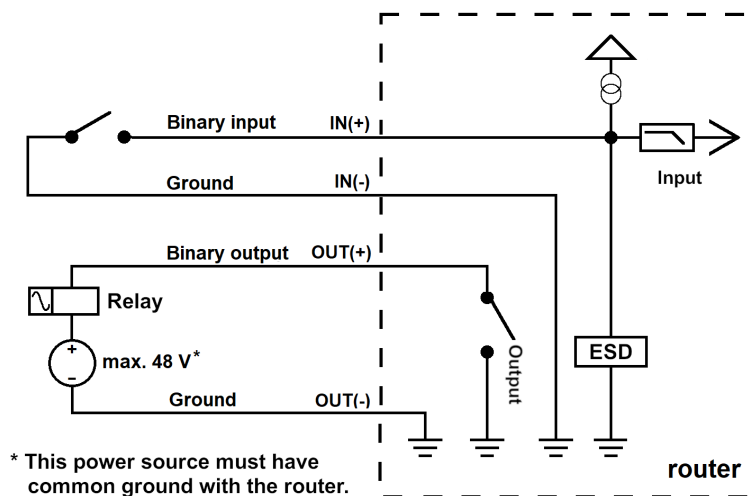

Figure 16: Functional Scheme of the Binary Interface

2.6 LED Status Indication

There are LED indicators on the front panel of the router to provide router status information. Moreover, ETH connector, has two additional LEDs providing information about the port status.

Caption	Color	State	Description
PWR	Green	On	The router is booting up.
	Green	Blinking	The router booted up and is ready.
	Green	Fast blinking	The router firmware is being updated.
USR	Green	—	The function of this LED is user-defined.
DI	Green	On	The binary input is active.
DO	Green	On	The binary output is active.
DAT	Green	Blinking	Cellular communication is in progress.
SIG	Green	On	Good cellular signal.
		Blinking	Fair cellular signal.
		Fast blinking	Poor cellular signal.
TECH	Green	On	The active SIM uses 4G technology.
		Blinking	The active SIM uses 3G technology.
		Fast blinking	The active SIM uses 2G technology.
SIM	Green	On	SIM is active for the cellular connection.
		Fast blinking	A SIM issue (missing card or PIN not entered).
ETH0	Green	On	Selected 100 Mbps bit rate.
	Green	Off	Selected 10 Mbps bit rate.
ETH0	Orange	On	The network cable is connected.
	Orange	Blinking	Data transmission.
	Orange	Off	The network cable is not connected.

Table 8: LED Status Indication

2.7 Reset Functions



Consider creating a router configuration backup before performing the router's factory reset.

The *RST* button can be used in three different scenarios:

- **Reset:** Hold the *RST* button for **less than 4 seconds**; the router will reboot, applying its customized configuration. The router reset can be initiated by clicking the *Reboot* menu item in the router web GUI.
- **Factory Reset:** To restore the default factory configuration of the router, press and hold the *RST* button for **more than 4 seconds**. After that, the *PWR* LED turns off and on again. We recommend holding the *RST* button for 1 second after turning on the *PWR* LED.
- **Emergency Factory Reset:** If the router cannot boot up due to the incorrect configuration, turn off the router (disconnect the power supply). Then, push and hold the *RST* button, turn on the router and hold the *RST* button for **at least 10 seconds**. The router configuration will be set to the default one.



It is necessary to use a narrow screwdriver or any other small tool to press the *RST* button.

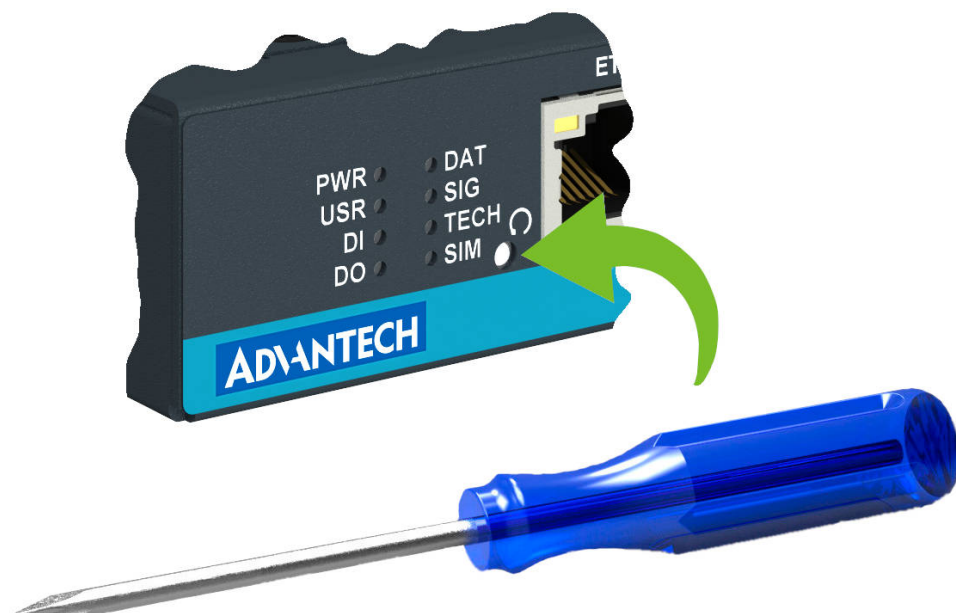

Figure 17: Resetting the Router

3. First Use

3.1 Accessories Connection

Before putting the router into operation, it is necessary to connect all the components required to run your applications; see Chapter 1.3 for the hardware overview. Remember to insert a SIM card for the cellular connection; see Chapter 2.1.



Do not run the router without antenna connected to the main antenna connector as the energy from the transmission is effectively reflected by the open end and can damage the equipment.

3.2 Router Configuration

Initial router configuration can be made via a web browser on your PC. Here you can perform router monitoring, configuration, and administration.

Connect the power supply to the router, see Chapter 2.4, and the router will boot up. By default, the router will automatically log on to the default APN of the inserted SIM card. Configure your PC to get the IP settings automatically from the network. Connect the network card of your PC to the default router LAN interface, Ethernet port ETH0, and the DHCP server will assign an IP address to your PC.

To get the router web interface, enter the <https://192.168.1.1> address in a web browser. Please note that usage of the HTTPS protocol for secure communication over the network is required.

There is just the `root` **user account** created on the router by default. See the **product label** on the router for its **default password**¹. Log in to the web interface with the `root` user and his password. If logged in successfully, the user will have access to the router web interface, see Figure 18. See the router configuration manual [1] for a detailed description and examples of the router configuration.



After logging on to the device for the first time, we strongly recommend changing the default password due to security reasons.



For security reasons, we recommend regularly updating the router's firmware to the latest version. Downgrading the firmware to an older version than the production version or uploading firmware intended for a different device may cause the device's malfunction.



All routers have the *WebAccess/DMP* client pre-installed by default. The activated client periodically uploads router identifiers and configuration to the *WebAccess/DMP* server. See the configuration manual [1], chapter *Basic Information -> WebAccess/DMP Configuration*, for more information.

¹Use the password `root` if the router's label does not contain a unique password.

ICR-2031 LTE Router

Name: N/A
Location: N/A

Status	General Status
Configuration	Mobile Connection
Customization	<p>SIM Card : 1st IP Address : 10.80.0.86 IPv6 Address : Unassigned Rx Data : 588 B Tx Data : 1.9 KB Uptime : 0 days, 8 hours, 43 minutes</p> <p>» More Information «</p>
Administration	ETH0
Users	<p>IP Address : 10.64.0.101 / 255.255.252.0 IPv6 Address : fd00:a40::101 / 56 MAC Address : 02:AD:FF:00:01:01 Rx Data : 166.2 KB Tx Data : 38.5 KB</p> <p>» More Information «</p>
Change Profile	Peripheral Ports
Change Password	<p>Binary Input : On Binary Output : Off</p>
Set Real Time Clock	System Information
Set SMS Service Center	<p>Firmware Version : 6.3.4 (2022-01-04) BETA #1506 Serial Number : ACZ1199000001015 Hardware UUID : N/A Profile : Standard Time : 2022-01-06 09:58:32 Uptime : 0 days, 8 hours, 43 minutes</p> <p>» Licenses «</p>
Unlock SIM Card	
Unblock SIM Card	
Send SMS	
Backup Configuration	
Restore Configuration	
Update Firmware	
Reboot	
Logout	

Figure 18: Router's Web Interface



A detailed description of the router settings in the web interface can be found in the configuration manual [1] of the router.

4. Technical Specifications

4.1 Basic Parameters

Parameter		Description
Temperature range	Operating Storage	-40 °C to +75 °C (-40 °F to +167 °F) -40 °C to +85 °C (-40 °F to +185 °F)
Humidity	Operating Storage	5 to 95 % relative humidity non condensing 5 to 95 % relative humidity non condensing
Altitude	Operating	2000 m / 70 kPa
Degree of protection		IP30
Supply voltage		9 to 48 V DC
Battery for RTC		CR2032 / CR1225 ¹
Consumption for non-WiFi (WiFi version)	Idle Average Maximum	1.8 W (2.1 W) 2.8 W (3.6 W) 3.3 W (4.0 W)
Dimensions of device w/o clip		103 × 95 × 25 mm (4.06" × 3.74" × 0.98")
DIN rail clip (optional part) specification		DIN 35 mm, EN 60715
Weight	Box w/o clip	335 g (0.74 lbs)
Antenna connectors	ANT, DIV WiFi	SMA female connectors for LTE – 50 Ω RP-SMA female connector for WiFi – 50 Ω
Interfaces	ETH0 PWR & I/O	RJ-45 socket for 10/100 Mbps Ethernet 6-pin socket for power supply and I/O interfaces

Table 9: Basic Parameters

¹For product revision 2.0 and higher.

4.2 Standards and Regulations

The router complies with the following standards and regulations:

Parameter	Description
Radio	EN 301 893, EN 300 328, EN 301 511, EN 301 908-1, EN 301 908-2, EN 301 908-13
EMC	EN 301 489-1, EN 301 489-17, EN 301 489-52, EN 61000-4-2, EN 61000-4-3, EN 61000-4-4, EN 61000-4-5, EN 61000-4-6, IEC 61000-6-2, IEC 61000-6-3, EN 55032
Safety	EN IEC 62368-1, UL E487720 ¹ , IEEE 802.3
Transportation	E-Mark (E8), homologation number: 10R - 06 14028 ¹
National	CE, UKCA compliant
Environmental	REACH, RoHS3 and WEEE compliant

Table 10: Standards and Regulations

¹For product revision 2.0 and higher.

4.3 Type Tests and Environmental Conditions

Phenomena	Test	Description	Test levels
ESD	EN 61000-4-2	Enclosure	CD ± 6 kV, L3
RF field AM modulated	EN 61000-4-3	Enclosure	20 V/m, 80 MHz-1 GHz, LX 10 V/m, 1 GHz-6 GHz, L3
Fast transient	EN 61000-4-4	DC port ETH - FTP Binary input Binary output	± 1 kV, 5/50 Tr/Th ns, 100 kHz, L2 ± 1 kV, 5/50 Tr/Th ns, 100 kHz, L3 ± 1 kV, 5/50 Tr/Th ns, 100 kHz, L3 ± 1 kV, 5/50 Tr/Th ns, 100 kHz, L3
Surge	EN 61000-4-5	ETH	± 1 kV, 1.2/50(8/20) Tr/Th us, L2
RF conducted	EN 61000-4-6	DC port ETH I/O ports	10 V, 0.15-80 MHz, 80%AM(1kHz), L3 10 V, 0.15-80 MHz, 80%AM(1kHz), L3 10 V, 0.15-80 MHz, 80%AM(1kHz), L3
Radiated emission	EN 55032	Enclosure	Class B, 30 MHz-1 GHz, 1 GHz-6 GHz
Conducted emission	EN 55032	DC power port Ethernet ports	Class B, 150 kHz-30 MHz Class B, 150 kHz-30 MHz
Dry heat	EN 60068-2-2	Operating Storage	Test Bb, storage +75 °C Test Bd, operation +85 °C
Cold	EN 60068-2-1	Operating Storage	Test Ab, storage -40 °C Test Ad, operation -40 °C
Variation of temperature	EN 60068-2-14	Test Nb, -40 °C / +75 °C, 3h/3h, 2 cycles, 3 K/min	
Dry heat, cyclic	EN 60068-2-30	+55 °C / +25 °C, rel. humidity 95 %, 6 h-6 h	

Table 11: Type Tests and Environmental Conditions

4.4 Parameters of Cellular Module

Parameter	Description
Antenna	Connector type: SMA Impedance: 50 Ω
LTE parameters	LTE: LTE Cat.4, 3GPP Rel. 11 FDD frequencies: B28A (700 MHz), B20 (800 MHz), B8 (900 MHz), B7 (2600 MHz), B3 (1800 MHz), B1 (2100 MHz) TDD frequencies: B41 (2500 MHz), B40 (2300 MHz), B38 (2600 MHz) Bit rates: up to 150 Mbps (DL), 50 Mbps (UL)
HSPA+/UMTS parameters	Supported frequencies: B8 (900 MHz), B1 (2100 MHz) Bit rates: up to 42 Mbps (DL) / 5.76 Mbps (UL)
EDGE/GPRS parameters	Supported frequencies: B8 (900 MHz), B3 (1800 MHz) Bit rates: up to 296 kbps (DL) / 236.8 kbps (UL)

Table 12: Technical Parameters of Cellular Module

4.5 Parameters of WiFi

Parameter	Description
Supported Standards	IEEE802.11 a/b/g/n/ac
Antenna connector	1x RP-SMA Input impedance: 50 Ω
Data Rate	802.11b: 1, 2, 5.5, 11Mbps 802.11a/g: 6, 9, 12, 18, 24, 36, 48, 54 Mbps 802.11n: Max. 72 Mbps @ 20 MHz channel 802.11n: Max. 150 Mbps @ 40 MHz channel
Frequency Ranges	2.4 GHz ISM Bands 2.412-2.472 GHz 5.15-5.25 GHz (FCC UNII-low band) for US/Canada and EU 5.25-5.35 GHz (FCC UNII-middle band) for US/Canada and EU 5.47-5.725 GHz for EU 5.725-5.825 GHz (FCC UNII-high band) for US/Canada
Modulation	DSSS, OFDM, DBPSK, DQPSK, CCK, 16-QAM, 64-QAM
2.4 GHz Channels	1, 2, 3, 4, 5, 6, 7, 8, 9, 10, 11, 12, 13
5 GHz Channels	36, 38, 40, 42, 44, 46, 48, 52, 56, 60, 64, 100, 104, 108, 112, 116, 120, 124, 128, 132, 136, 140, 149, 153, 157, 161, 165
Type of Device	Access point (AP) Station (STA) Multirole (STA&AP)
Security – Standards	WPA, WPA2, WPA3, 802.1X
Security – Encryption	WEP, TKIP, AES
TX Power	Max. 18 dBm @ 2.4 GHz Max. 15 dBm @ 5 GHz

Table 13: Technical Parameters of WiFi

4.6 Parameters of I/O Ports

Electrical characteristics of the binary input are in Table 14. Status of the binary input is reported in the GUI on *General Status* page or can be retrieved in the Shell via `io get bin0` command.

get command output	Voltage	Web interface status
0	$\leq 0.8\text{ V (0.5 mA)}$	On
1	$\geq 2\text{ V}$	Off

Table 14: Electrical Characteristics of Binary Input

The maximum binary output load is **100 mA** at **9 – 48 V**.

4.7 System Configuration

The main parameters of the system are listed in Table 15.

Parameter	Description
CPU architecture	ARM926EJ-S
CPU frequency	600 MHz
CPU power	4,72 DMIPS/MHz
Flash memory	64 MB NOR Flash <ul style="list-style-type: none"> • 12 MB for Router Apps • 2 MB for customer data
RAM size	128 MB
Watchdog	HW Watchdog
RTC	Battery Backup RTC

Table 15: System Configuration

Appendix A: Troubleshooting

If you cannot connect to the router from your PC, your network card may be configured in such a way that it is not possible to connect to the router. Take one or more of the following steps in order to solve the problem:



- Make sure your PC's network card is configured to obtain the IP address from the DHCP server (by default the DHCP server is running in the router).
- Connect the router to the PC via Switch.
- Connect the router to the PC, start the router first and then start the PC after the router's initialization.

Ethernet connection fails or is not establishing.

- *It is possible to turn auto negotiation off and set a rate and duplex manually on the Ethernet interface of the router. Available on "LAN Configuration" page in the router.*

Mobile WAN connection fails.

- *Check the signal power ("Mobile WAN status" page). If the signal power is weak, you will have to use a better antenna. If the neighbouring cells have a similar signal strength, you will need to use a directional antenna. For proper operation, the signal levels have to be good.*
- *Try to enable automatic ping from the router, which will check the connection when there are no data running and in the case of a failed ping, restart the connection. This can be done on the "Mobile WAN Configuration" page in the router in the "Check connection" section. "Enable + bind" option is to ensure the ping goes always through Mobile WAN network interface.*

Mobile WAN connection cannot be established.

- *Check the "Mobile WAN Configuration" – APN, name, password and IP address (all can be blank).*
- *Try to enter the SIM card PIN – verify that the SIM card has the PIN code entered. Available on "Unlock SIM Card" page in the "Administration" section.*
- *In a private APN it is not recommended to get the DNS settings from operator (on "Mobile WAN" page)*
- *Go to "System Log" page in "Status" section and observe where the error occurs.*

I cannot connect from the Internet to the device behind the router. I have NAT enabled.

- *The device's gateway has to be configured so it points to the router.*

 **I can't access my Web server placed behind the router over NAT.**

- *The remote HTTP access to the router has to be disabled on "NAT Configuration" page in the router. Also enable "Send all remaining incoming packets to default server" feature and fill in the IP address of your Web server. On the Web server, the default gateway has to be the IP address of the router.*

 **DynDNS doesn't work.**

- *With private APN this will not work.*
- *If the same IP address is recorded in your canonic name as a dynamically assigned address, it means that the operator is using NAT or a firewall.*
- *You can verify NAT using ping to your server with static address and then compare with router's IP address.*
- *You can verify a Firewall by accessing remotely to the router's Web interface.*
- *The operator may not provide the address of DNS server and without DNS server's address it is impossible to connect to the dyndns.org server. The following messages will be shown in the System Log:*
 - *DynDNS daemon started*
 - *Error resolving hostname: no such file or directory*
 - *Connect to DynDNS server failed*

 **L2TP or IPSec isn't establishing.**

- *Check the "System Log" page for error messages.*

 **IPSec tunnel establishes but the communication does not run.**

- *Probably there are bad routing rules defined in the connected devices, or the default gateway.*

 **I switched the router to offline mode by SMS message, but the router is in online mode after reboot.**

- *SMS messages do not change the router configuration. They remain in effect only until the router is rebooted.*

Serial communication is not working.

- *Verify that the router model supports serial communications. Also verify the serial communication settings. To do so, open the router's configuration menu via the web browser, select the appropriate "Expansion Port" from "Configuration" part of the menu and verify the settings.*

Is the router Cisco compatible? Can I use the Cisco configuration?

- *No, the Firmware in the router (Conel OS) is based on Linux with BusyBox. Thus the Cisco configuration cannot be used. But network connections are defined by standards so connecting the router to the Cisco or other networking devices is possible and will be compatible.*

FTP or SFTP does not work

- *FTP will work on v2 routers only. You can use SFTP on all routers to transfer files to/from the router. If having troubles with FTP on v2 routers, make sure you have FTP enabled: "Configuration" section, "Services", "FTP". Then you can connect with any client on port 21 with name and password same as for the Web interface. If having troubles with SFTP, make sure you have SSH enabled: "Configuration" section, "Services", "SSH". Then you can connect with any client on port 22 with name and password same as for the Web interface.*

How can I connect to the router's command line? (SSH, Telnet)

- *You can use SSH on all routers or Telnet on v2 routers only. SSH is enabled by default, but you can verify in Web interface in "Configuration" section, "Services", "SSH". Then connect with any SSH client on port 22 of the router. User and password is the same as for the Web interface. Telnet on v2 routers can be enabled here: "Configuration" section, "Services", "Telnet".*

Appendix B: Customer Support

Customer Support for Europe

Advantech Czech s.r.o.

Sokolska 71
562 04, Usti nad Orlici
Czech Republic

Phone: +353 91 792444
Fax: +353 91 792445
E-mail: iiotcustomerservice@advantech.eu
Web: www.advantech.com

Customer Support for NAM

Advantech B+B SmartWorx

707 Dayton Road
Ottawa, IL 61350 USA

Phone: +1-800-346-3119 (Monday – Friday, 7 a.m. to 5:30 p.m. CST)
Fax: +1-815-433-5109
E-mail: support@advantech-bb.com
Web: www.advantech-bb.com

Customer Support for Asia

Phone: +886-2-2792-7818 #1299 (Monday – Friday, 9 a.m. to 5:30 p.m. UTC+8)
Fax: +886-2-2794-7327
E-mail: icg.support@advantech.com.tw
Web: www.advantech.com

Appendix C: Regulatory & Safety Information

Safety Notices



Please, observe the following instructions:

- The router must be used in compliance with all applicable international and national laws and in compliance with any special restrictions regulating the utilization of the router in prescribed applications and environments.
- To prevent possible injury and damage to appliances and to ensure compliance with all relevant provisions, use only the original accessories. Unauthorized modifications or the use of unapproved accessories may result in damage to the router and/or a breach of applicable regulations. Unauthorized modifications or use of unapproved accessories may void the warranty.
- The router can not be opened.
- Turn off the router and disconnect it from power supply before handling the SIM card.
- **Caution!** This equipment is not suitable for use in locations where children are likely to be present. The SIM card could be swallowed by small children.
- Power supply must not exceed 48 V DC max.
- Do not expose the router to extreme ambient conditions. Protect the router against dust, moisture and high temperature.
- Only routers with appropriate certification and labelling should be used in locations where flammable and explosive materials are present, including gas stations, chemical plants, or locations in which explosives are used. We remind users of the duty to observe the restrictions concerning the utilization of radio devices at such places.
- Switch off the router when travelling by plane. Utilization of the router on a plane may endanger the operation of the plane or interfere with the mobile telephone network, and may be unlawful. Failure to observe these instructions may result in the suspension or cancellation of telephone services for the respective client and/or may result in legal sanctions.
- When using the router in close proximity to personal medical devices, such as cardiac pacemakers or hearing aids, you must proceed with heightened caution.
- The router may cause interference when used in close proximity to TV sets, radio receivers or personal computers.
- It is recommended that you create an appropriate copy or backup of all important settings that are stored in the memory of the device.



Product Disposal Instructions

The WEEE (Waste Electrical and Electronic Equipment: 2012/19/EU) directive was introduced to ensure that electrical/electronic products are recycled using the best available recovery techniques to minimize the environmental impact. This product contains high quality materials and components which can be recycled. At the end of its life this product **MUST NOT** be mixed with other commercial waste for disposal. The device contains a battery. Remove the battery from the device before disposal. The battery in the device needs to be disposed of apart accordingly. Check the terms and conditions of your supplier for disposal information.

Appendix D: Related Documents

[1] ICR-2[0456]00 Configuration Manual



[EP] Product-related documents and applications can be obtained on **Engineering Portal** at <https://icr.advantech.cz/download> address.



We, Advantech Czech s.r.o., declare that the radio equipment narrated in this user's manual complies with Directive **2014/53/EU**.



We, Advantech Czech s.r.o., declare that the radio equipment narrated in this user's manual complies with Radio Equipment Regulations 2017 (**S.I. 2017 No. 1206**).

The full text of the EU Declaration of Conformity is available at the following internet address:
icr.advantech.cz/eudoc